

MASTERBUILT®

Hopper Exhaust Grate Replacement, Gravity Series



CAUTION



- Always remove plug from outlet before servicing your grill.
- Make sure your grill has fully cooled to avoid burns.
- Some components may have sharp edges. Use caution to avoid injury.

Note: Your grill may vary from images shown

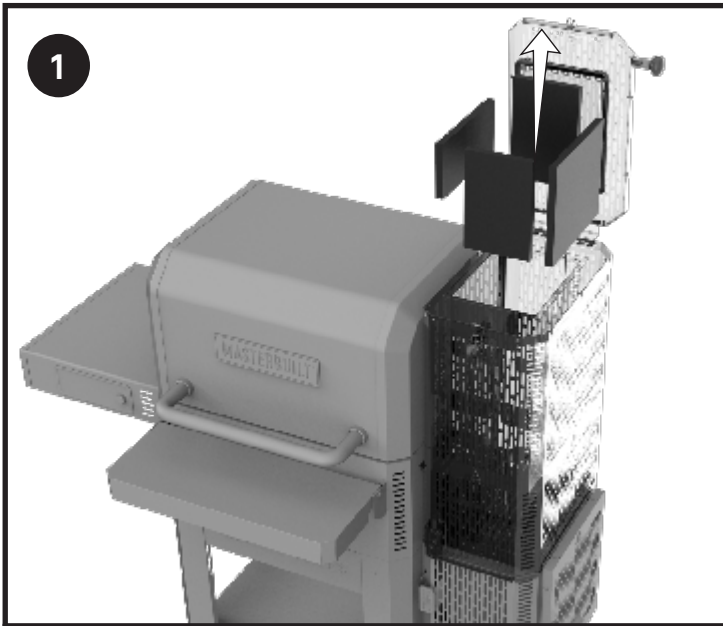

Remove all 4 firebricks from inside of the hopper.

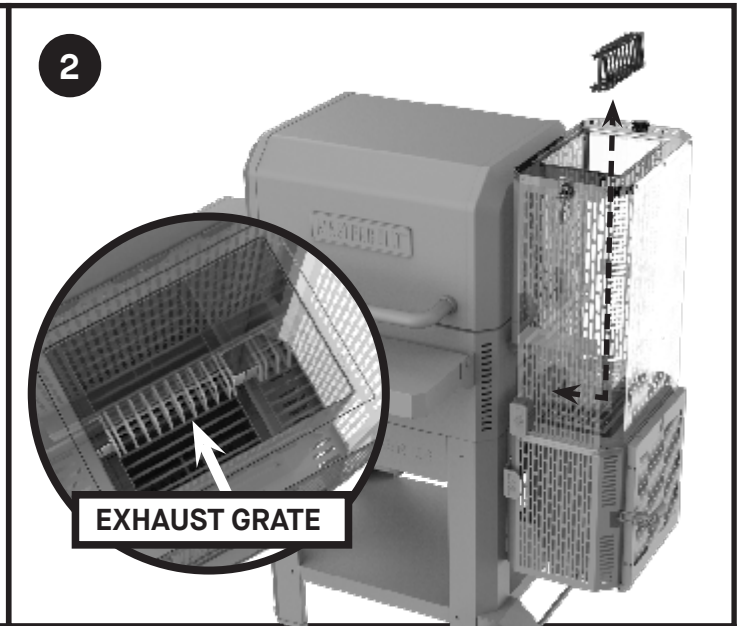

Remove the old exhaust grate and replace.

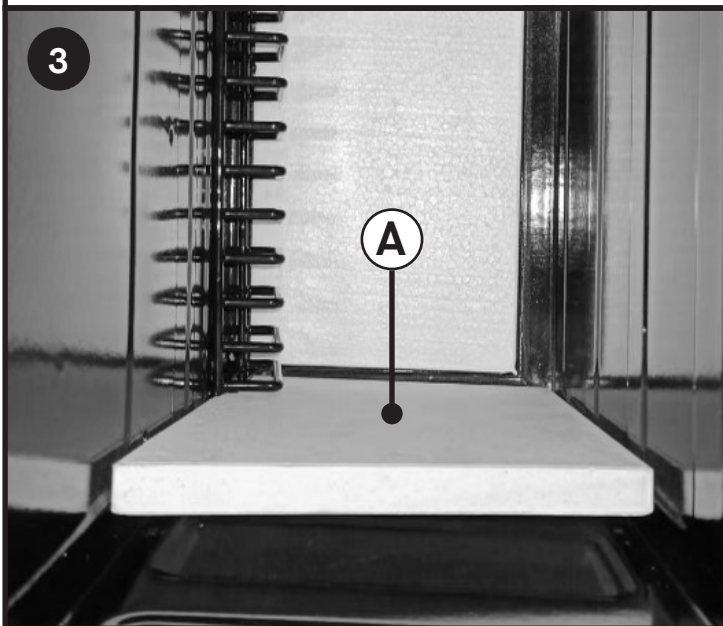

Replace panel A.

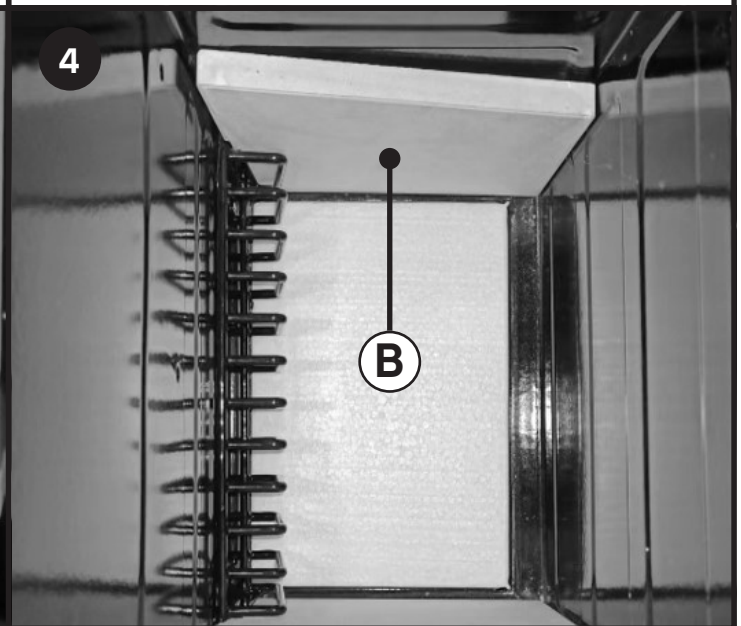

Replace panel B.

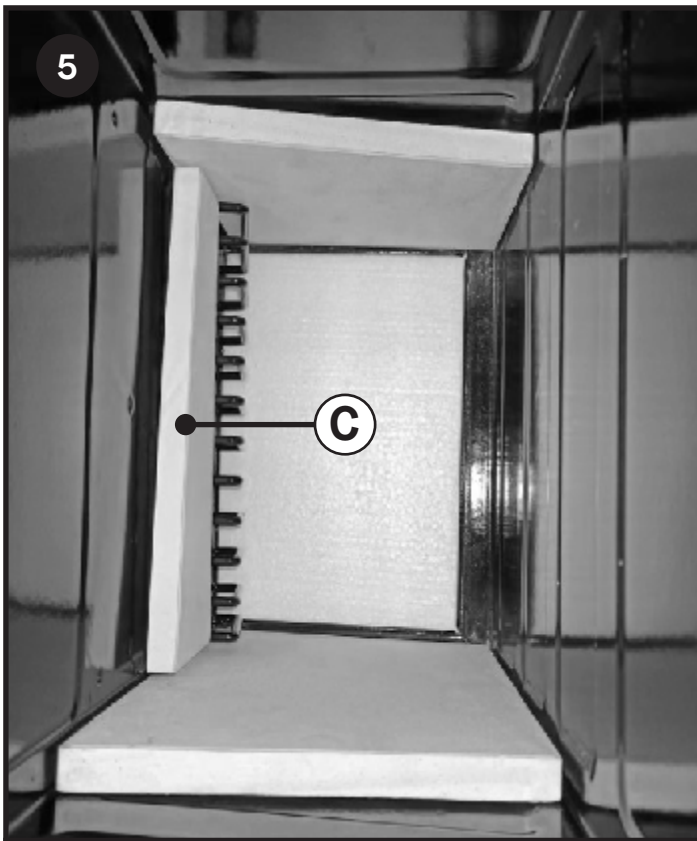

Replace panel C.

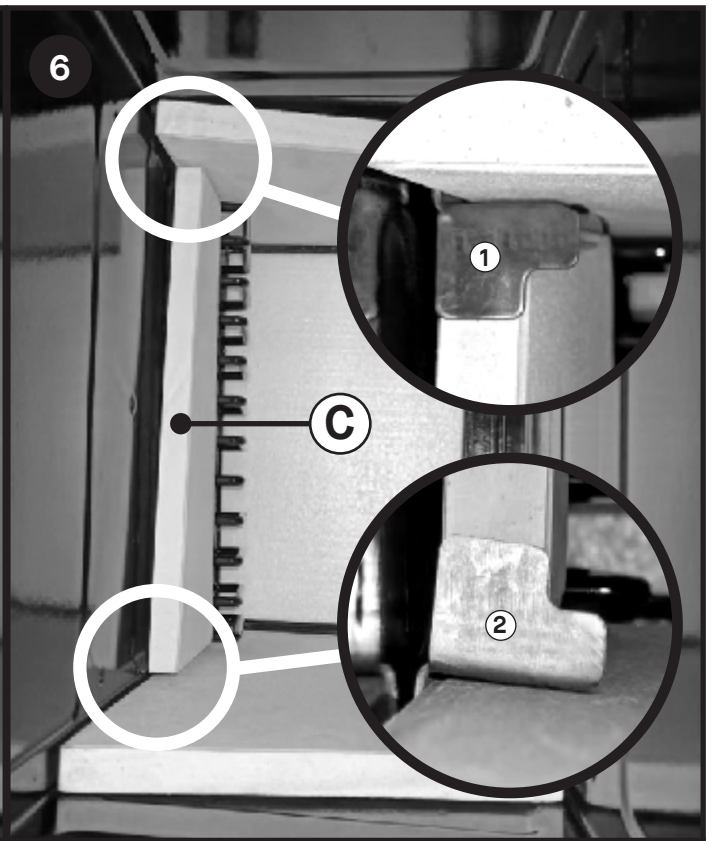

Add Bracket 1 and 2.

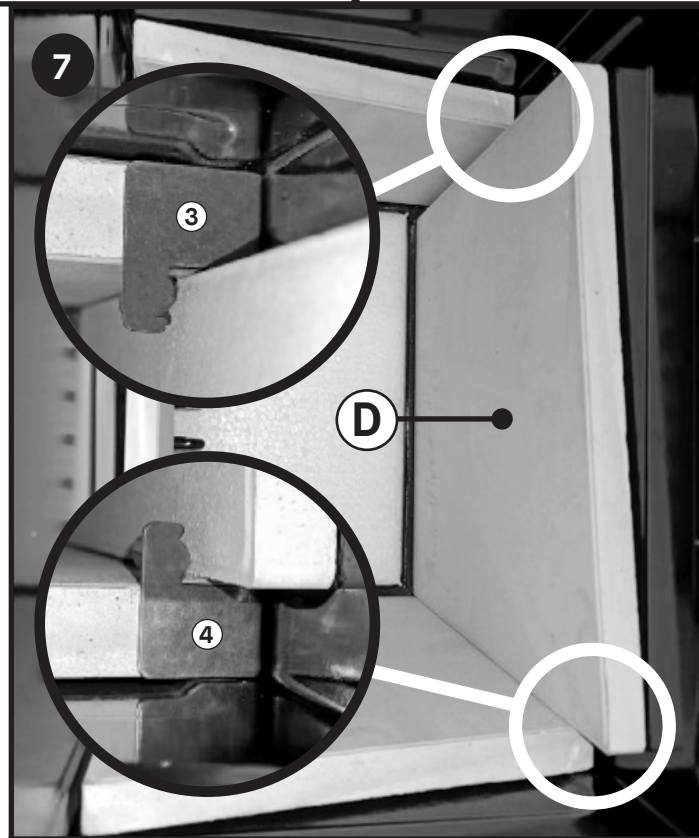

Replace panel D. Add bracket 3 and 4.