

MASTERBUILT®

GSG 1150 Housing Kit Replacement



CAUTION

- Make sure the grill has cooled completely before handling to avoid burns.
- Some components may have sharp edges. Use caution and wear protective gloves to avoid injury.
- Power OFF the grill and disconnect the power from the wall before handling.



1

Remove the heat intake slide.

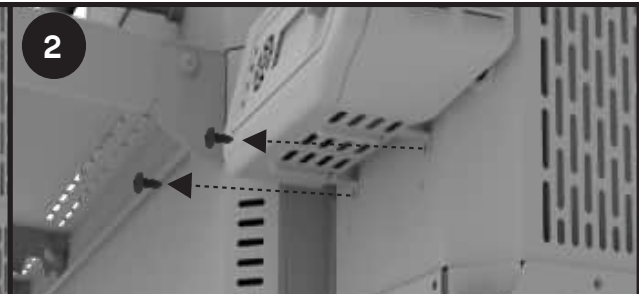

2

Remove 2 screws to detach the controller kit from the hopper.

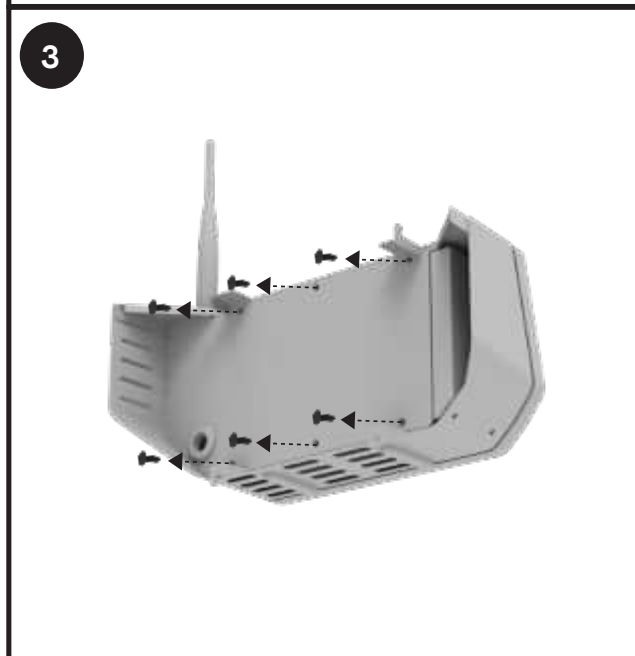

3

Remove 6 screws from rear of the controller kit to open the back panel.

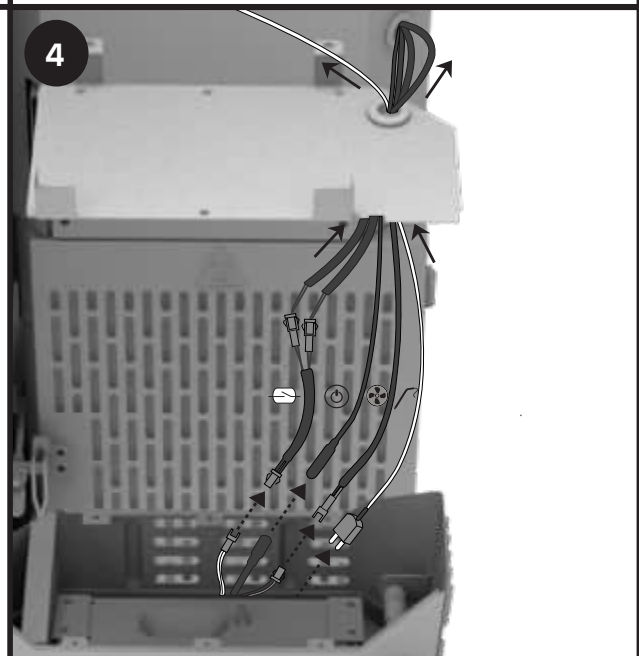

4

Disconnect the 4 wires and pull them out of the hole.

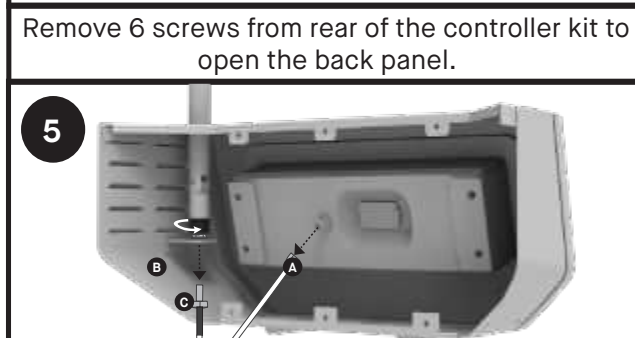

5

Remove the antenna and the wire.

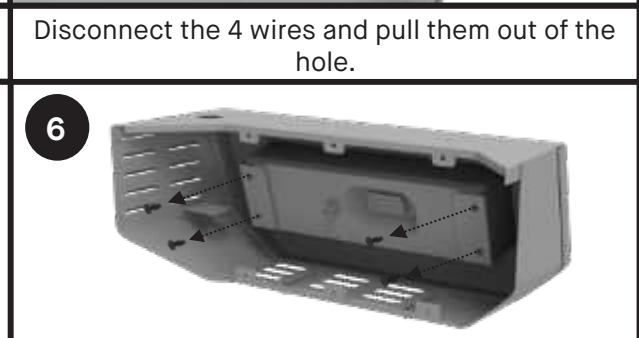

6

Unscrew 4 screws to remove the controller.

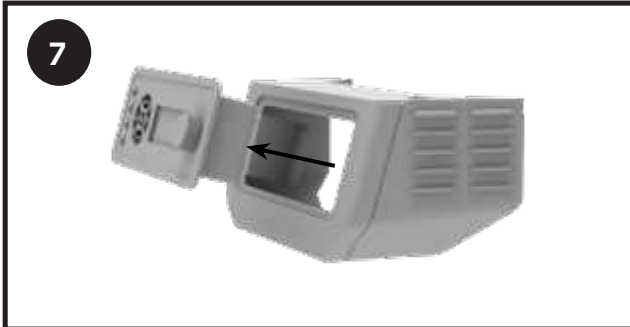

Pull the controller out of the failed housing.

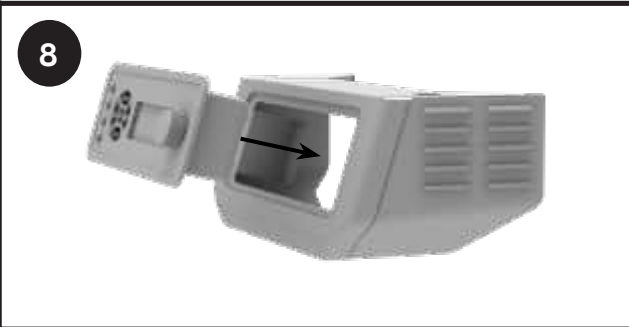

Pull the controller into new housing.

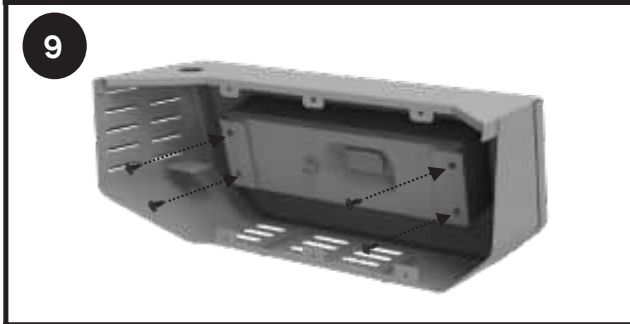

Reinstall the controller with 4 screws.

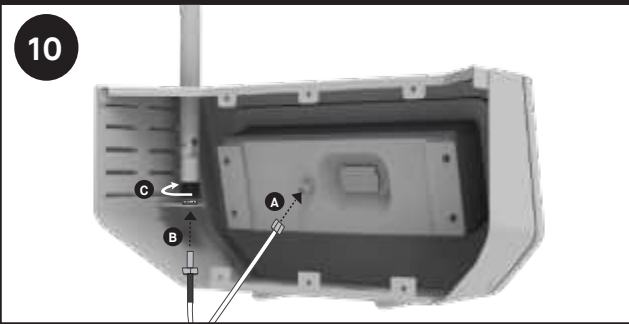

Reinstall the antenna and wire.

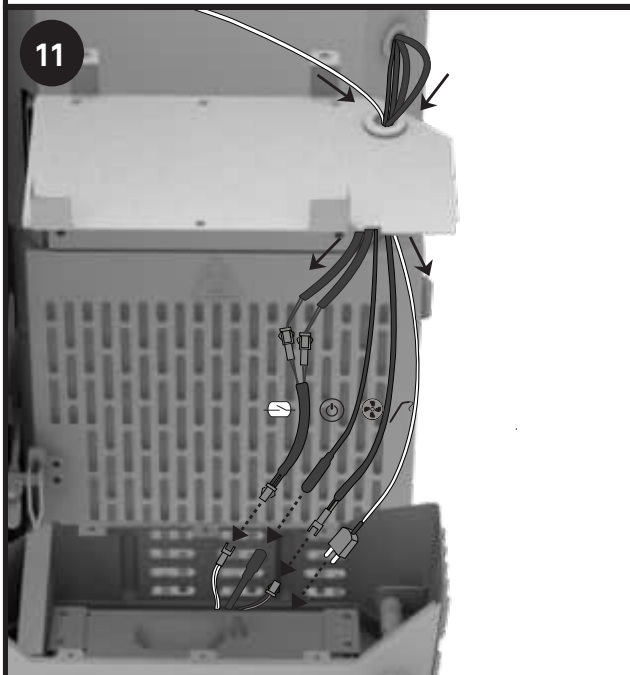

Pull the 4 wires into the hole and connect them.



Reinstall the back panel of the controller kit.



Reinstall the controller kit on the hopper with 2 screws.



Put the heat intake slide in place.